

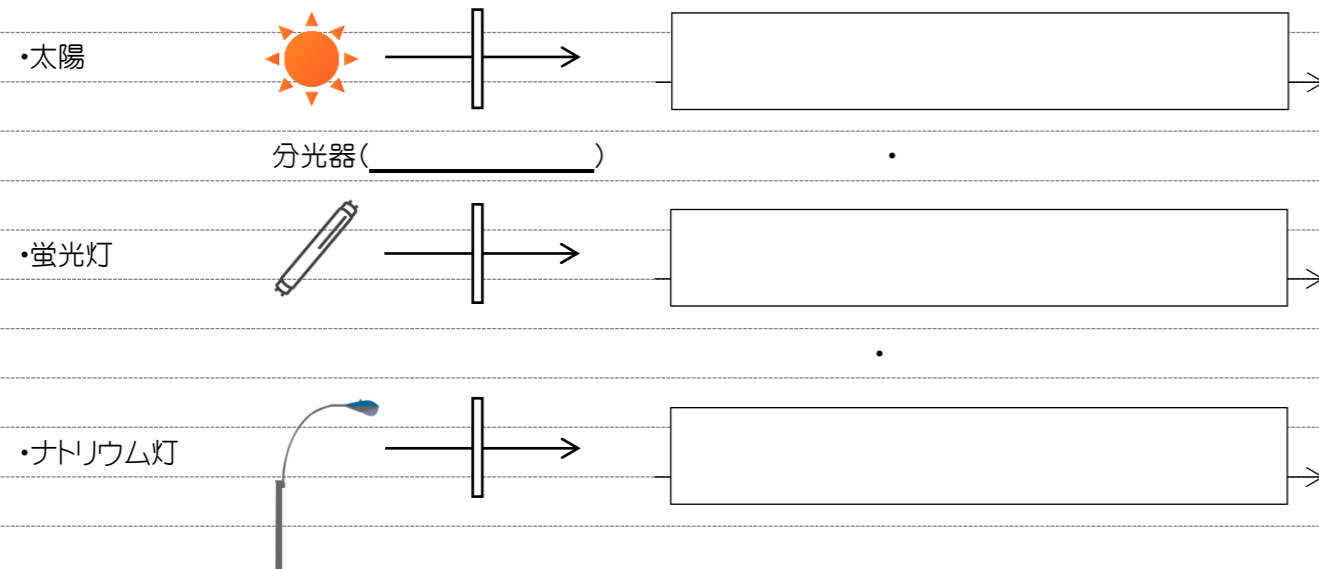

【科学と人間生活】「 光の性質とその利用 」 No.8

3



2 節 <目に見える光と色の見え方>

1 光の3原色と色

() Red 、() Green 、() Blue

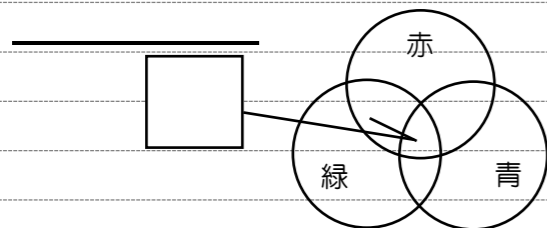

- (1)
- (2)
- (3) 人による色の認知

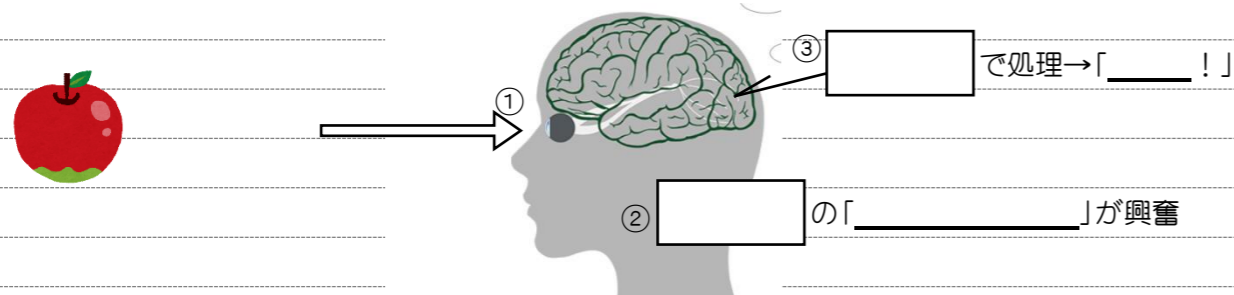

④ 視細胞 =

※裏面参照

(4)

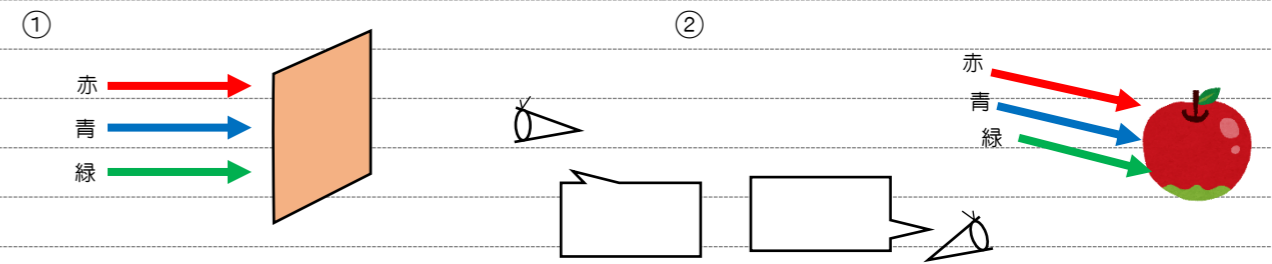

2

(1)

① 散乱のしやすさ

短 波長 長

② 散乱の様子

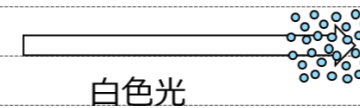

③ 空の色

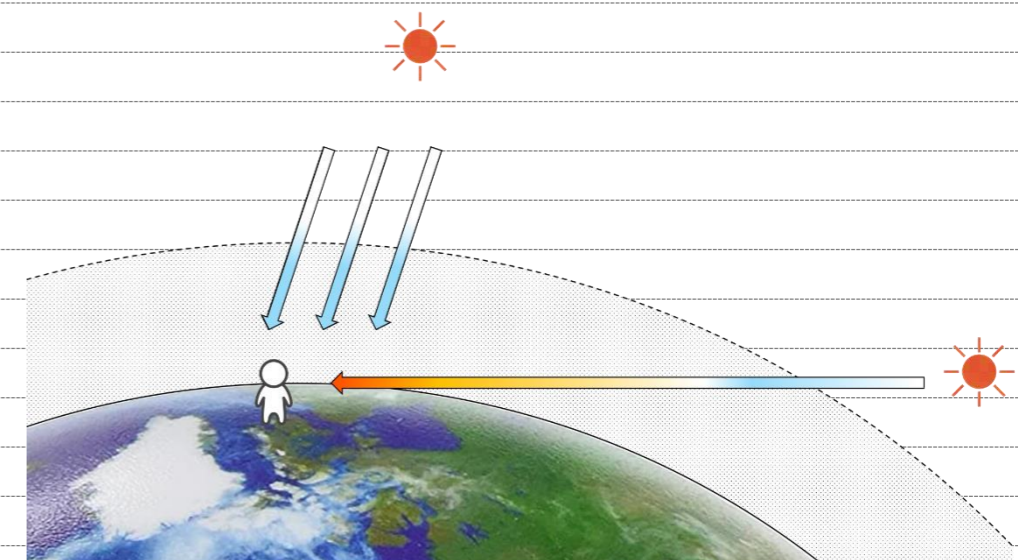

(2)

① 散乱のしやすさ

短 波長 長

② 散乱の様子

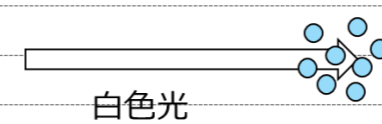

参考 錐体細胞の感度分布

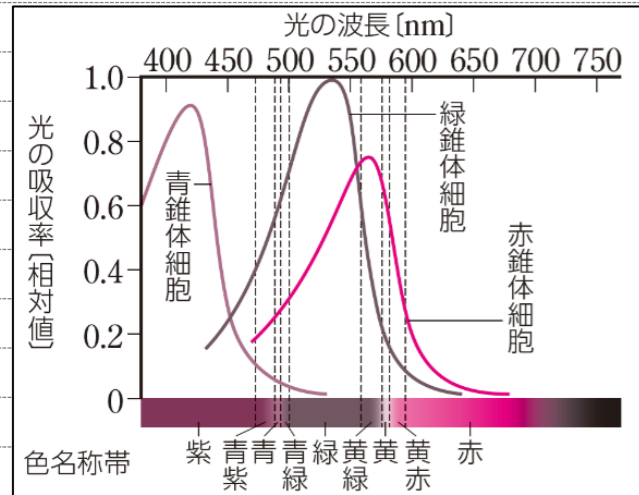

参考 網膜の断面図

